

1

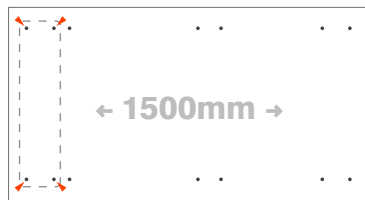

Positions for frames(legs)



2

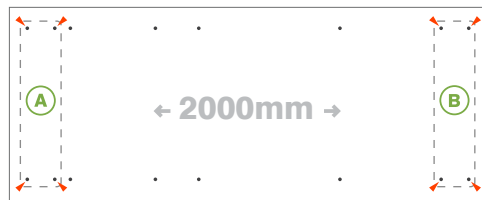
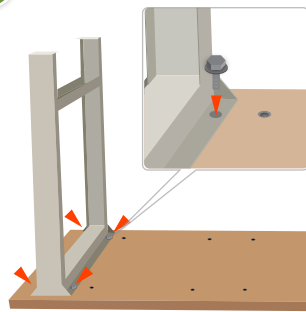

3

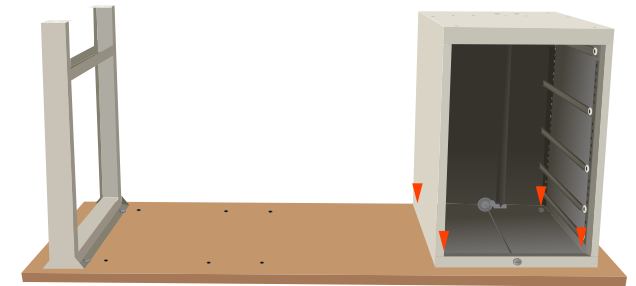

Positions for suspended drawer

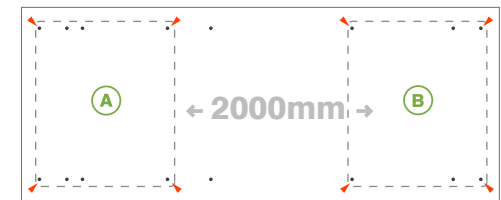
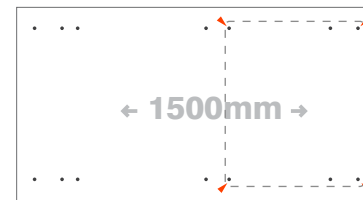

4

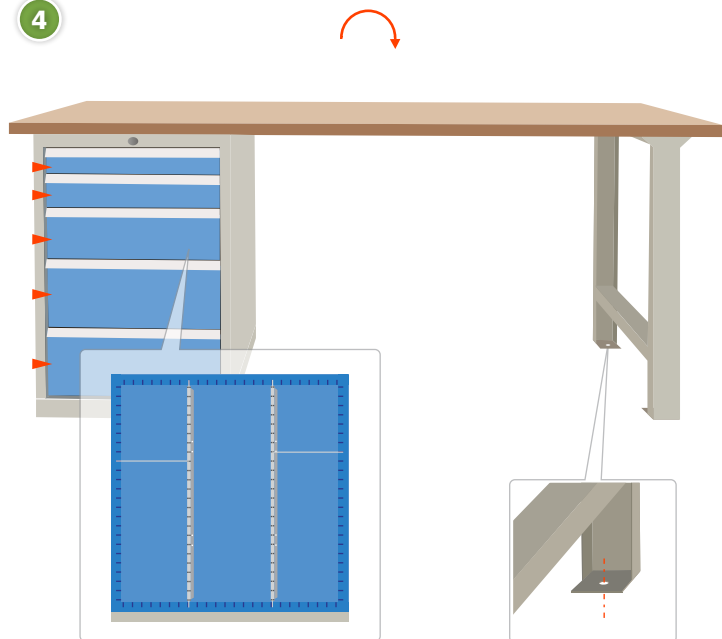

*Dividers are installed into the drawer slots

**Fix-to-floor ready

Loading capacities

Workbenches

← 1500mm →

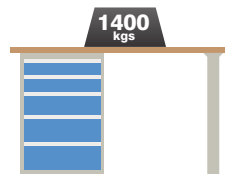

← 2000mm →

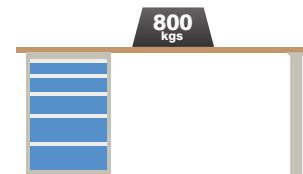

Drawers

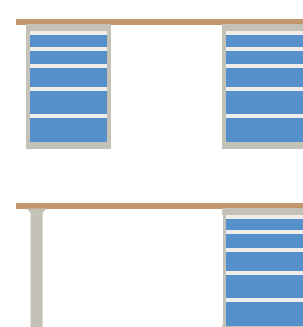
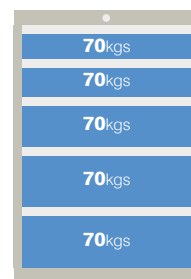

1. Place the worktop on the floor, the fitting side up.

2. Attach the frame (legs) to one side of the worktop using M10 bolts with washers, tighten with 17mm spanner.

3. Take the drawers out of the drawer cabinet and place it on top of the worktop (upside down) - matching the bolting positions on the worktop and the holes inside the cabinet. Attach the cabinet using M10 bolts and tighten with 17mm spanner.

4. Turn the assembled workbench on its feet and insert the drawers back into the cabinet.

**optional dividers can be installed at this point*

***the workbench can be fixed to the floor*

Tools Required

17mm Spanner

Safety Precaution

Two competent people wearing **safety gloves**, **safety shoes** and **protective eyewear** are recommended to undertake the assembly.

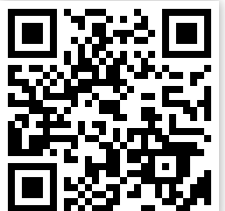

scan for more info